



KIT#1345 trim
TKIT#1345PATQ



Specifications

Composition

- TPATQ45C - 3-way Type T/P coaxial valve trim
- 2020C - Hand shower rail
- 488C - 20 cm (8") shower head
- 533C - 50 cm (20") shower arm
- 847C - Wall-mount tub spout
- 720C - Elbow supply

Available colors

- C : Chrome
- BN : Brushed Nickel (PVD)

Certifications

- CSA B125.1
- ASME A112.18.1
- ASSE 1016
- CMR248 Approval

UPC®

Warranty

This **Riobel Inc.** product you have purchased carries a Limited Lifetime Warranty on the chrome, PVD finish, blacks and all working parts and is guaranteed from the initial purchase date against all manufacturing defects. All other finishes, including plastic components, are guaranteed for one year. All electric and/or electronic parts are covered by a 5-year limited warranty.

Customer Service

Ontario, West Canada : 888-287-5354 Quebec, Maritimes, United States : 866-473-8442

2021.07.19



3-way Type T/P coaxial valve trim
TPATQ45



Specifications

Descriptions

- 6 positions (OFF, 1, 1 and 2, 2, 2 and 3, 3) share
- Trim only
- Thermostatic/pressure balance coaxial cartridge with check valves
- R45, R45-SPEX or R45-EX rough required to complete

Available colors

- C : Chrome
- BN : Brushed Nickel (PVD)

Available flow

- 23 L/min, 6.0 gpm (US) 60psi

Certifications

- CSA B125.1
- ASME A112.18.1
- ASSE 1016
- CMR248 Approval
- ADA

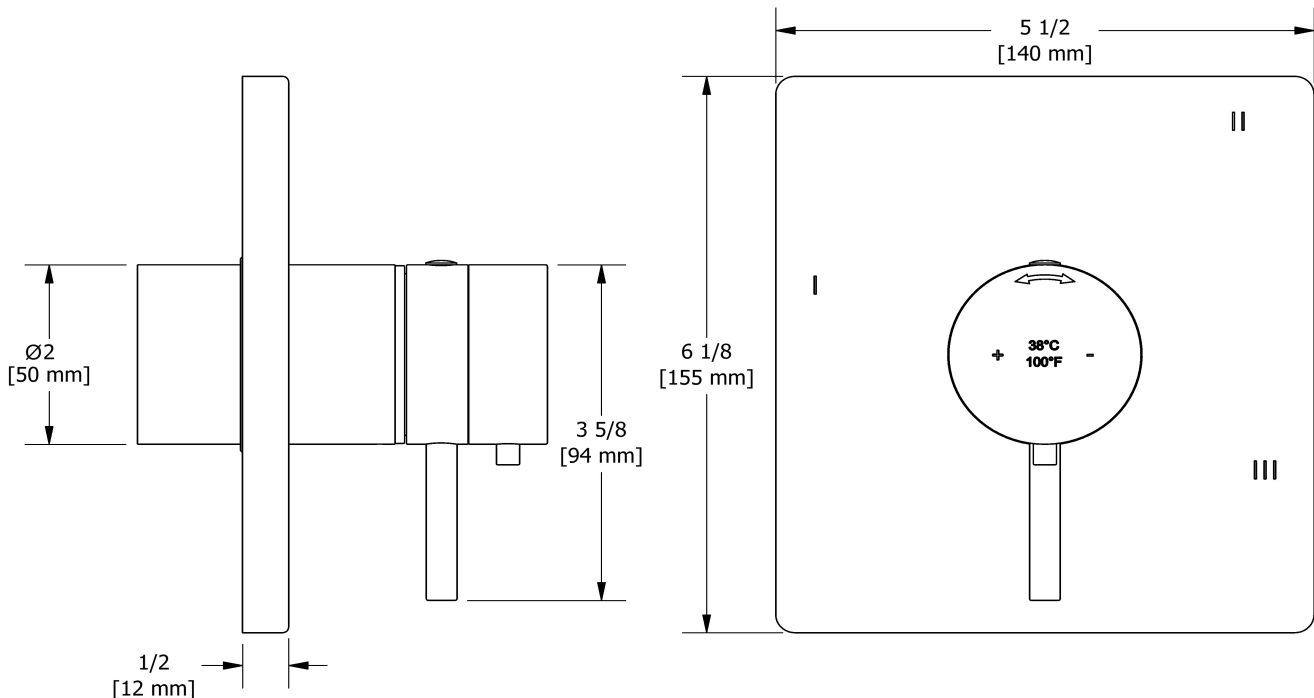

Sizes, models and finishes may differ from those presented.

Warranty

This **Riobel Inc.** product you have purchased carries a Limited Lifetime Warranty on the chrome, PVD finish, blacks and all working parts and is guaranteed from the initial purchase date against all manufacturing defects. All other finishes, including plastic components, are guaranteed for one year. All electric and/or electronic parts are covered by a 5-year limited warranty.

Customer Service

Ontario, West Canada : 888-287-5354 Quebec, Maritimes, United States : 866-473-8442

2021.07.19



Hand shower rail
2020



Specifications

Descriptions

- 10, 4-jet hand shower with pause
- Scale-free
- 150 cm (59") double interlock flexible hose, swivel and 2 check valves
- Ø19 mm (¾") slide bar
- Easy-Glide left cursor

Available colors

- C : Chrome
- BN : Brushed Nickel (PVD)
- PN : Polished Nickel (PVD)

Available flows

- 6.7 L/min, 1.8 gpm (US) 60psi
- 5.69 L/min, 1.5 gpm (US) 60psi (2020-15)
- 6.8 L/min (1.80 gpm) max / 5.1 L/min (1.35 gpm) (45 psi) (2020-WS) *

EPA certification applicable to the indicated model only

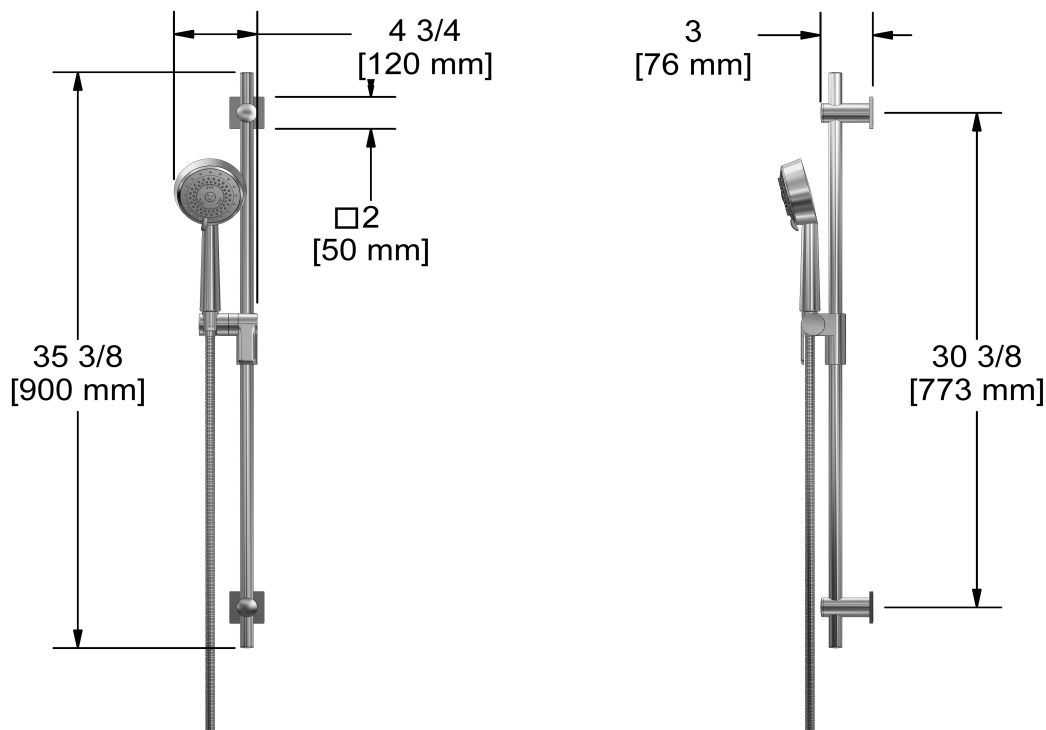

Sizes, models and finishes may differ from those presented.

Warranty

This **Riobel Inc.** product you have purchased carries a Limited Lifetime Warranty on the chrome, PVD finish, blacks and all working parts and is guaranteed from the initial purchase date against all manufacturing defects. All other finishes, including plastic components, are guaranteed for one year. All electric and/or electronic parts are covered by a 5-year limited warranty.

Customer Service

Ontario, West Canada : 888-287-5354 Quebec, Maritimes, United States : 866-473-8442



20 cm (8") shower head
488

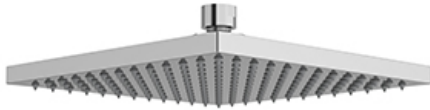

Specifications

Descriptions

- Scale-free
- Swivel
- G $\frac{1}{2}$ " inlet female

Available colors

- C : Chrome
- BN : Brushed Nickel (PVD)

Available flows

- 7.6 L/min, 2.0 gpm (US) 60psi
- 5.69 L/min, 1.5 gpm (US) 60psi (**488-15**)
- 6.6L/min, 1.75 gpm (US) 60psi (**488-WS**) *

EPA certification applicable to the indicated model only

Certifications

- CSA B125.1
- ASME A112.18.1
- CMR248 Approval

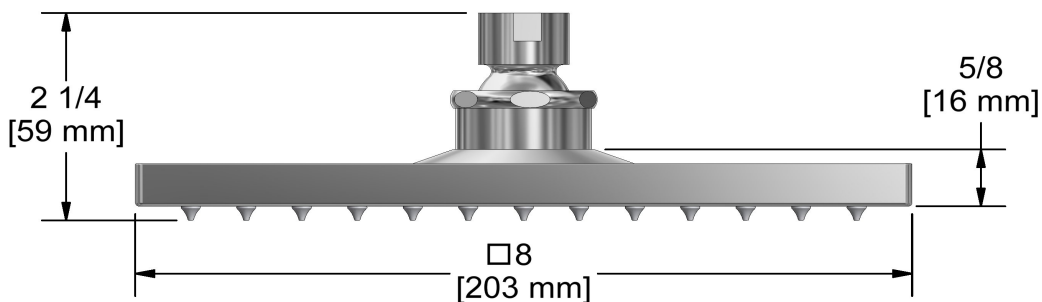

Sizes, models and finishes may differ from those presented.

Warranty

This **Riobel Inc.** product you have purchased carries a Limited Lifetime Warranty on the chrome, PVD finish, blacks and all working parts and is guaranteed from the initial purchase date against all manufacturing defects. All other finishes, including plastic components, are guaranteed for one year. All electric and/or electronic parts are covered by a 5-year limited warranty.

Customer Service

Ontario, West Canada : 888-287-5354 Quebec, Maritimes, United States : 866-473-8442



50 cm (20") shower arm
533

Specifications

Descriptions

- 1/2" inlet male NPT
- Square flange with set screw

Available colors

- C : Chrome
- BN : Brushed Nickel (PVD)
- PN : Polished Nickel (PVD)

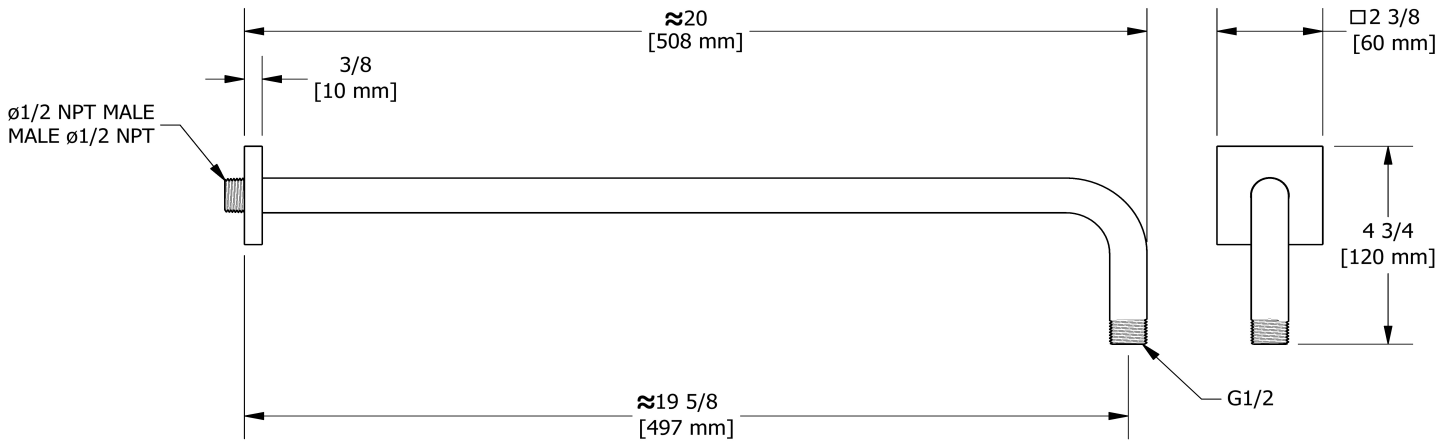

Sizes, models and finishes may differ from those presented.

Warranty

This **Riobel Inc.** product you have purchased carries a Limited Lifetime Warranty on the chrome, PVD finish, blacks and all working parts and is guaranteed from the initial purchase date against all manufacturing defects. All other finishes, including plastic components, are guaranteed for one year. All electric and/or electronic parts are covered by a 5-year limited warranty.

Customer Service

Ontario, West Canada : 888-287-5354 Quebec, Maritimes, United States : 866-473-8442

2021.07.19



Wall-mount tub spout
847



Specifications

Descriptions

- 1/2" copper slip fit inlet
- Brass
- Drilling hole diameter = 1 (25mm)

Available colors

- C : Chrome
- BN : Brushed Nickel (PVD)

Certifications

- CSA B125.1
- ASME A112.18.1
- CMR248 Approval

UPC®

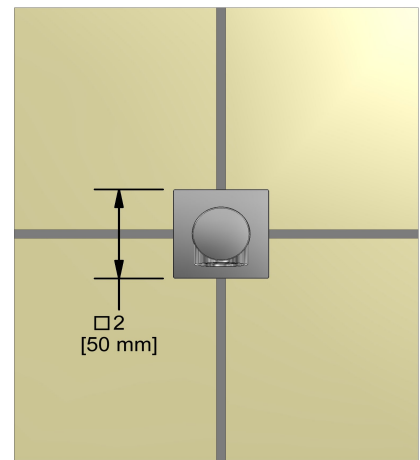
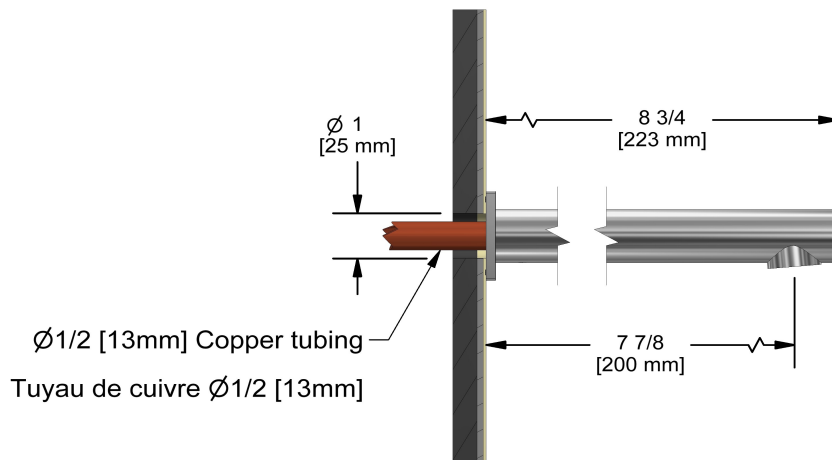

Sizes, models and finishes may differ from those presented.

Warranty

This **Riobel Inc.** product you have purchased carries a Limited Lifetime Warranty on the chrome, PVD finish, blacks and all working parts and is guaranteed from the initial purchase date against all manufacturing defects. All other finishes, including plastic components, are guaranteed for one year. All electric and/or electronic parts are covered by a 5-year limited warranty.

Customer Service

Ontario, West Canada : 888-287-5354 Quebec, Maritimes, United States : 866-473-8442

2021.07.19



Elbow supply
720



Specifications

Descriptions

- 1/2" outlet male
- 1/2" inlet female NPT
- Adjustable depth

Available colors

- C : Chrome
- BN : Brushed Nickel (PVD)

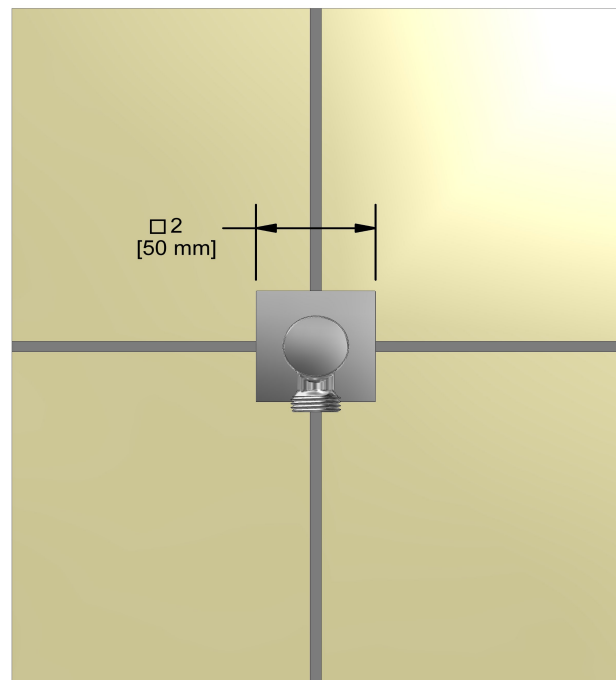
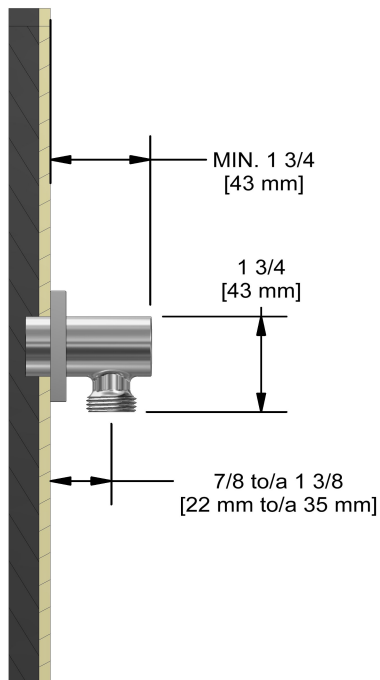

Sizes, models and finishes may differ from thoses presented.

Warranty

This **Riobel Inc.** product you have purchased carries a Limited Lifetime Warranty on the chrome, PVD finish, blacks and all working parts and is guaranteed from the initial purchase date against all manufacturing defects. All other finishes, including plastic components, are guaranteed for one year. All electric and/or electronic parts are covered by a 5-year limited warranty.

Customer Service

Ontario, West Canada : 888-287-5354 Quebec, Maritimes, United States : 866-473-8442

2021.07.19