



Single hole lavatory faucet
RU01



Specifications

Descriptions

- Push drain
- 3/8" speedway compression
- Ceramic cartridge

Available colors

- C : Chrome
- PN : Polished Nickel (PVD)

Available flows

- 4.5 L/min, 1.2 gpm (US) 60psi *
- 1.9 L/min, 0.5 gpm (US) 60psi (**RU01-05**)
- 3.7 L/min, 1 gpm (US) 60psi (**RU01-10**)

EPA certification applicable to the indicated model only

Certifications

- CSA B125.1
- NSF/ANSI standard 61 and 372
- ASME A112.18.1
- CMR248 Approval
- ADA

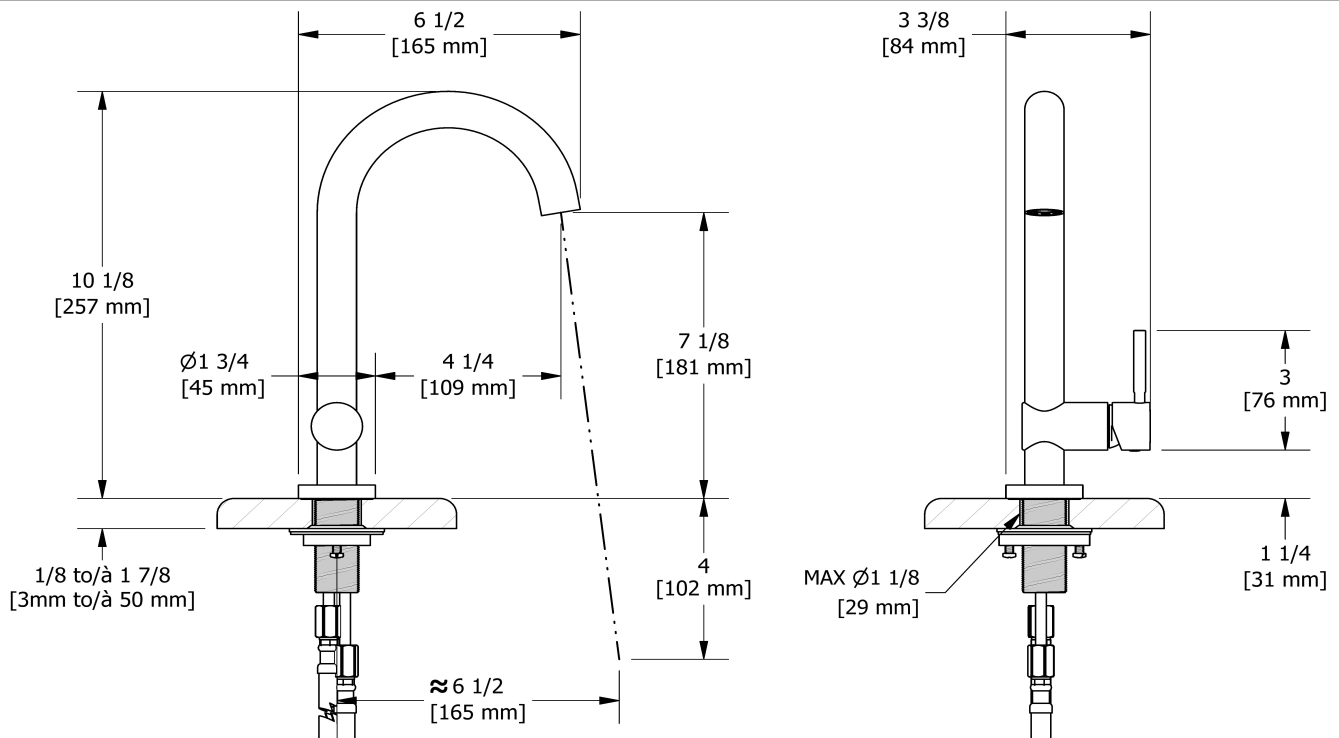

Sizes, models and finishes may differ from those presented.

Warranty

This **Riobel Inc.** product you have purchased carries a Limited Lifetime Warranty on the chrome, PVD finish, blacks and all working parts and is guaranteed from the initial purchase date against all manufacturing defects. All other finishes, including plastic components, are guaranteed for one year. All electric and/or electronic parts are covered by a 5-year limited warranty.

Customer Service

Ontario, West Canada : 888-287-5354 Quebec, Maritimes, United States : 866-473-8442